



Light System Manager

Author, configure, and control intricate LED light shows in multiple zones



Light System Manager

Author, configure, and control intricate LED light shows in multiple zones

Optimized for medium and large-scale LED lighting installations, Light System Manager controller (LSM) is an integrated hardware and software solution comprising Light System Engine (LSE) controller hardware and Light System Composer (LSC) creative design software. With support for intricately designed installations containing thousands of LED nodes, Light System Manager offers the versatility to manage wide-ranging architectural, entertainment, and retail lighting environments.

- Easy to use — Featuring Ethernet-based control and automatic lighting system discovery, Light System Manager dramatically simplifies installation.
- Hardware support for medium and large environments — Light System Engine hardware processes simultaneous light output data for up to 15,000 individually controllable LED nodes, depending on configuration.
- Improved reliability — Solid-state drives reduce the number of moving parts to enhance the reliability of the LSE hardware.
- Slimmer profile — Slimmer form factor offers convenient surface mounting, as well as the ability to install in server racks and rackmount cases.
- Flexible mounting options — Integrated mounting tabs allow installation overhead, on vertical surfaces, or on moving architectural or entertainment features.
- Packaged with Light System Composer — Light System Composer software allows you to create and manage dynamic light shows with fully customizable effects, multi-layer editing, and unique color palettes. You can design shows with single or multiple color-changing effects, animated images, geometric patterns, and more.
- Versatile zone usage — Configure and control multiple playback zones, each with up to unique light show assignments. Light System Manager allows zone control of both indoor and outdoor fixtures within a single installation.
- Simplified control access — Designed for use with LSM, Ethernet Controller Keypad is a wall-mounted triggering device that controls light shows and fixture brightness at the touch of a button. LSM supports up to 10 keypads within a single lighting installation.
- Automatic playback control — Configure show scheduling based on a specific date, a day of the week, weekdays, or weekends.
- Support for IntelliWhite lighting fixtures — Light System Manager offers visual effects with color temperature and intensity settings designed specifically for IntelliWhite white light fixtures.
- Supports the optional AuxBox expansion device — AuxBox automatically triggers up to eight light shows using any remote triggering device with a dry-contact closure. Via the AuxBox, you can trigger light shows by motion sensors, third-party control or sensor systems, and more.

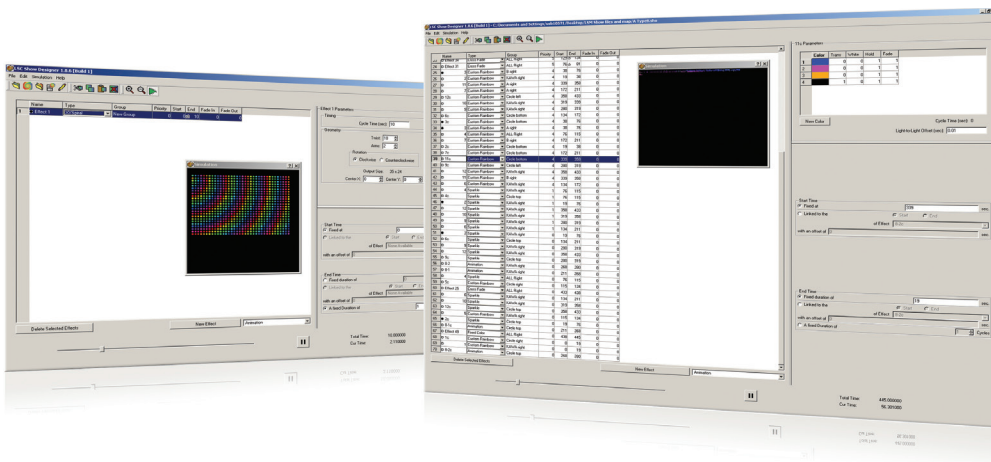

Design and Manage Multi-Layered Light Shows

The Show Designer module in Light System Composer provides the flexibility to design shows based on your creative vision.

Show Designer allows you to incorporate graphics and images for eye-catching visual presentations.

Each light show effect is fully customizable. For sophisticated results, modify effect variables, such as color palettes and transitions.

Transform Cityscapes with Energy-Efficient Light



CN Tower
Toronto, Canada



Photography Jerrold Litwinenko

Transforming the CN Tower

For nearly a decade, the 1,815 ft (553 m) CN Tower was minimally lit in an effort to conserve energy while awaiting a better long-term lighting solution. Following extensive evaluation, a Philips Color Kinetics lighting system was chosen to visually transform the Tower's appearance while also reducing energy consumption and maintenance requirements. According to the CN Tower's calculation, the entire LED installation consumes 60% less energy than the fully illuminated Tower of the 1990s, and 10% less energy than the previous system.

Lighting Control and Configuration

With its scalable design, Light System Manager offers the ideal controller solution for the CN Tower project. Installed with standard Ethernet cabling and network hardware, LSM manages the 1,300 high-performance lighting fixtures mounted within the Tower's elevator shafts and antenna tower.

What's in a Light System Manager Light Show?

A light show is a set of digital instructions orchestrating how and when your lighting installation displays effects. The CN Tower lighting design team created mood, interest, and visual impact by customizing the appearance and behavior of standard Light System Composer effects with unique color palettes, sequences, and playback zones. Additionally, via the show scheduling feature, specifically themed light shows display automatically to coincide with national events and holidays.



✳ For full details on using the software modules to design your lighting installation, refer to the *Light System Manager user guide* available at www.philipscolorkinetics.com/lsc/controllers/lsm/

Light System Manager Environments

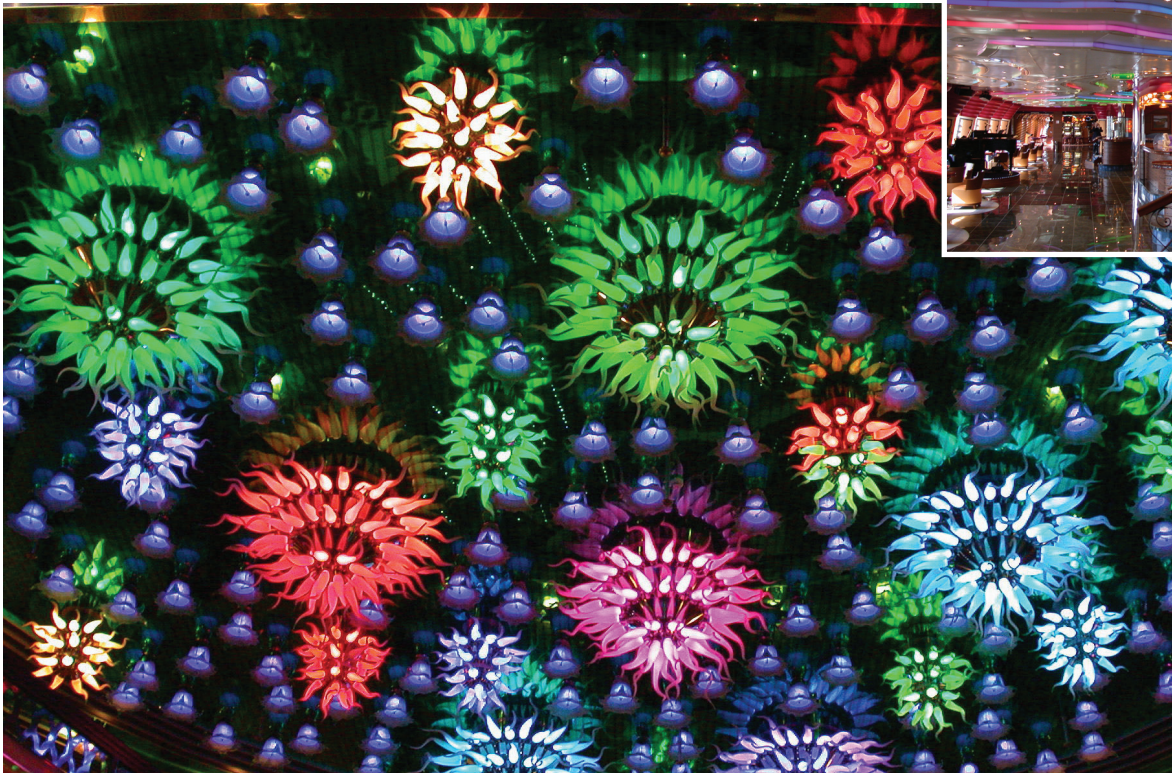

Costa Concordia
Genoa, Italy

Photography Piero Comparotto

Multi-zone Installation

Costa Concordia is the largest and most technologically advanced ship among Italy's Costa Cruise line fleet. The expansive ship features a visually striking interior with a series of engaging environments highlighted by LED lighting fixtures from Philips Color Kinetics.

With custom-designed chandeliers that resemble glowing, colorful sea urchins, the main atrium dazzles passengers entering the Costa Concordia. The chandeliers are illuminated by iColor MR g2 lamps, which fit most common MR16 fixtures. Moving to the main lounge, passengers encounter a curved ceiling with diffused, linear tubes enclosing flexible strands of iColor Flex SL. Each strand has 50 full-color LED nodes that are individually controllable. The fixture configuration allows for graphical patterns and color sequences to chase across the ceiling. Each successive environment onboard the ship stands out for its unique visual appearance and physical form.

Costa Cruise line selected Light System Manager as the lighting control solution for the Costa Concordia. LSM offers a convenient and cost-effective control solution, with zone control allowing simultaneous display of varied show content in separate areas of the ship. The ship's main atrium, main lounge, aft lounge, aft atrium, dance lounge, "Tavernetta," creative room, and spa each comprise a separately controlled zone. Rather than requiring a separate DMX-based controller for each zone, the entire installation is controlled from a central location by LSM.

For ease of installation, Light System Manager offers an Ethernet-based system compatible with conventional network hardware. LSM's support for up to 15,000 individually controllable LED nodes is an important factor for the Costa Concordia, where each zone contains 1,250 or more LED nodes or fixtures.



Boathouse Row
Philadelphia, Pennsylvania

Photography Jacques-Jean Tiziou

Architectural Exterior

A popular Philadelphia landmark, Boathouse Row comprises twelve boating clubs in ten architecturally distinct buildings along a half-mile stretch of the Schuylkill River. The lighting system from Philips Color Kinetics replaces a 30-year-old incandescent system that required frequent and costly maintenance.

Like the CN Tower, Boathouse Row uses LED lighting to transform a well-known but static exterior scene into an expressive canvas. The lighting design team envisioned a primary display of white light with the capability to punctuate the boathouses with vibrant color and visual effects for special occasions. The designers accomplished their goal by creating shows with the Show Designer module in Light System Composer. The straightforward and easy-to-use software interface enabled the team to focus on the creative aspects of the project rather than configuration. New users were able to program and submit light shows for conceptual approval in a matter of minutes, with limited prior experience using Light System Manager.



Hard Rock Hotel & Casino Biloxi
Biloxi, Mississippi

Photography Buddy Pope, 4Wall
Entertainment Lighting

Architectural Interior

The restored Hard Rock Hotel & Casino Biloxi opened its doors on lucky 7.7.07 (July 7, 2007) after suffering extensive damage from Hurricane Katrina. LSM's scalable, Ethernet-based design proved critical to the success of the complex project, which features intricate and varied designs for the thousands of LED nodes and fixtures within the hotel. Light System Manager's compatibility with commonly used network components allowed for reliable and seamless installation.

Light System Manager controls eight separate lighting zones, including the Hard Rock Biloxi Memorabilia Wall, which pays homage to Rock and Roll's greatest influences. The fixtures from Philips Color Kinetics used in the two story display feature zero ultraviolet and infrared emissions, preventing damage to the display's priceless contents.



Georgia Aquarium
Atlanta, Georgia

Photography Kieran Reynolds Photography

Theater and Entertainment

The wave wall installed in the Georgia Aquarium's central plaza is 150 x 25 ft (45.7 x 7.6 m) and comprises five curving bands of color-changing light. The wave wall acts as an immersive visual centerpiece to incoming visitors.

Additionally, the wall doubles as a 75 ft (22.9 m) wide projection surface for video shows. For video presentation, the fixtures in the center of the wall turn off, creating a white "video screen", and the fixtures along the perimeter of the wall remain on, creating a colorful frame surrounding the presentation.

Specifications

Due to continuous improvements and innovations, specifications may change without notice.

Item	Specification	Details
Electrical	Input Voltage	100 – 220 VAC, auto-switching
	Power Consumption	180 W max.
Capability	Supported LED Nodes	Up to 15,000 LED nodes
	Network Data	KiNET Ethernet protocol* via standard Ethernet switch†
	Playback Output	Light shows containing one or more visual effects
Physical	Dimensions (Height x Width x Depth)	9.1 x 11 x 3.5 in (230 x 280 x 88 mm)
	Weight	9.3 lb (4.2 kg)
	Operating Temperature	32 – 95° F (0° – 35° C)
	Operating Humidity	0 – 90%, relative humidity, non-condensing
Certification and Safety	Certification	UL / cUL, FCC, CE, CCC, C-Tick
	Environment	Indoor / Dry location

* KiNET is the Ethernet lighting protocol from Philips Color Kinetics.



† Use PoE (Power-over-Ethernet) switches, or PoE injectors, when installing a lighting system containing one or more Ethernet Controller Keypads.

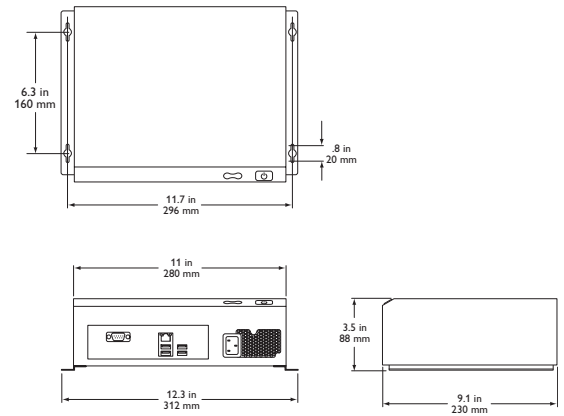

Software Requirements

System Requirements	Specification	PC	Mac
Software	Operating System	Vista / Windows 7	Mac OS X 10.9 or greater
Hardware	Optical Drive	CD-ROM or DVD drive	CD-ROM or DVD drive
	Memory	256 MB RAM	256 MB RAM
	Disk space	10 MB free disk space	10 MB free disk space

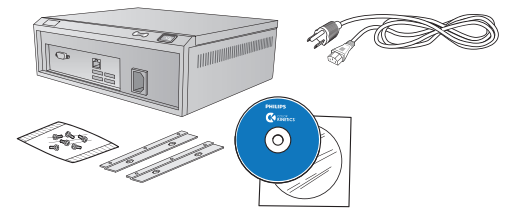

Included in the Box

Light System Manager
Power cable
(2) Mounting brackets and (6) Mounting screws
Software CD
Quick Start Guide
Installation Instructions

Light System Manager and Accessories

Item	Item Number	Philips 12NC
Light System Manager	103-000015-03	910503700626
Ethernet Controller Keypad	103-000023-00	910503700326
PoE Injector (North America Power Cord)	109-000029-00	910503700383
PoE Injector (Europe Power Cord)	109-000029-01	910503700384
AuxBox	103-000021-01	910503702433

Use Item Number when ordering in North America.

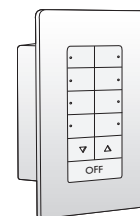

Ethernet Controller Keypad

Ethernet Controller Keypad is a wall-mounted triggering device that controls up to eight light shows and lighting fixture brightness at the touch of a button.

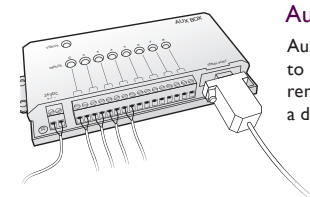

AuxBox

AuxBox instantly activates up to eight light shows using any remote triggering device with a dry-contact closure.

Configuration Overview

Light System Manager allows your lighting installation to display a variety of light show designs and choreographed moving images. LSM comprises Light System Engine, a computer (for initial setup and programming), one or more Ethernet Controller Keypads (optional), network hardware, and lighting components.

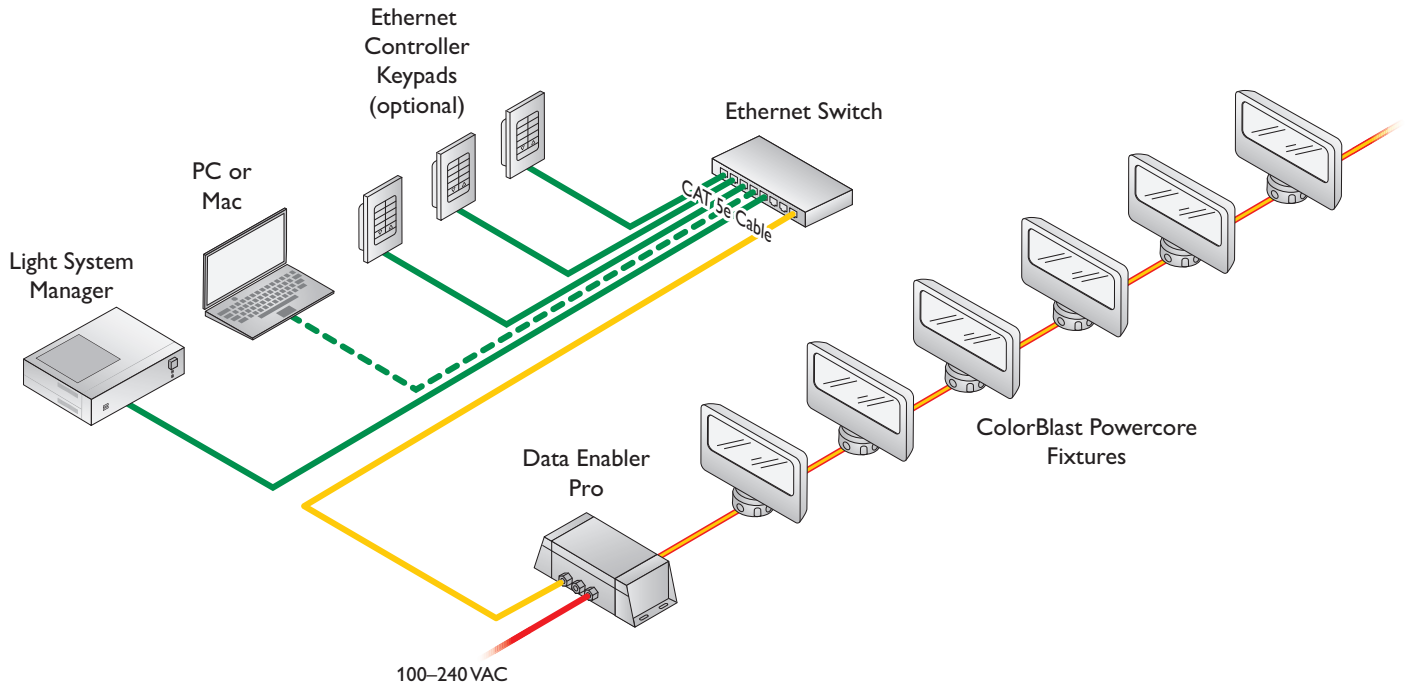

Ethernet Layout

Light System Engine hardware communicates with the interfaces in the lighting installation (power / data supplies and Data Enabler Pro devices) via KiNET Ethernet, the network protocol engineered by Philips Color Kinetics for high-performance lighting system control. LSE offers full compatibility with all conventional Ethernet hardware, accommodating network trees up to three switches deep between the LSE and the farthest KiNET interface. Ethernet limits the maximum cable run to 328 ft (100 m). Adding Ethernet optical data cabling and hardware to your layout extends the maximum cable run distance.

Ethernet Controller Keypads are PoE (Power over Ethernet) devices. Use PoE-compatible Ethernet switches if Ethernet Controller Keypads are installed on the network. Alternatively, if using non-PoE switches, install PoE injectors from Philips Color Kinetics inline between each keypad and switch.

Dedicated Local Area Network

To achieve optimal display and network connectivity performance, the LSE and all lighting components must be installed on a dedicated Local Area Network. Light System Engine hardware delivers thousands of packets of light output data per second to your lighting installation, requiring uninterrupted data throughput.

Automatic Interface Discovery and Creating Maps

Light System Engine references a map file when communicating with the lighting components in the network. The map allows the LSE to identify every fixture and interface in the installation as a separate device and route data accordingly. For your convenience, the Management Tool module in Light System Composer automatically discovers all connected Ethernet interfaces and fixtures, including their IP addresses and device names.

* For optical device Ethernet network specifications, refer to your optical device user documentation.

Prepare for the Installation

Owner / User Responsibilities

It is the responsibility of the contractor, installer, purchaser, owner, and user to install, maintain, and operate the Light System Manager system in such a manner as to comply with all applicable codes, state and local laws, ordinances, and regulations. Consult with an appropriate electrical inspector to ensure compliance.

Planning the Installation

Philips Color Kinetics offers lighting systems suitable for environments ranging from the simplest to the most complex. A simple LSM installation might use 25 ColorGraze Powercore fixtures installed in a single zone, whereas a larger LSM installation might use 200 strands of iColor Flex SLX displaying light shows in multiple zones. Regardless of the size and complexity of your project, the time you spend up front can help minimize installation and configuration issues. Keep these suggestions in mind as you plan your installation:

1. Create a lighting design (CAD layout, architectural plan, or other diagram) that specifies the locations of all lighting fixtures, power / data supplies, Data Enabler Pro devices, Ethernet switches, Ethernet cables, the Light System Engine, and Ethernet Controller Keypads.
2. Use the online Configuration Calculator, and the appropriate Product Guides and wiring diagrams, to determine the number of fixtures each circuit in your installation can support, based on type of fixture, power source, line voltage, circuit load, and cable lengths.
3. Light System Manager is an Ethernet-based system offering flexible and convenient installation options. Note that Ethernet limits maximum individual cable runs to 328 ft (100 m). For larger installations, adding Ethernet optical data cabling and hardware to your lighting network extends the maximum cable run distance.
4. As part of the lighting design plan, where possible, make use of a repeated layout that specifies the preferred orientation of each fixture. For example, if using iColor Tile MX fixtures, install each fixture in a uniform manner so that jumper cables plug into the same side of each fixture in a sequence.
5. The Management Tool module in Light System Composer automatically discovers all connected Ethernet power /data supplies, Data Enabler Pro devices, and addressable fixtures. As needed, use QuickPlay Pro addressing and configuration software to assign unique IP addresses and device names to all power / data supplies, Data Enabler Pro devices, and addressable fixtures before using the Management Tool to map your installation.
6. To streamline physical installation and future maintenance, affix a weatherproof label identifying installation placement, IP address, and device name to an inconspicuous location on each power / data supply, Data Enabler Pro, and fixture housing.
7. Refer to the Light System Manager User Guide for instructions on using the modules in Light System Composer to map your installation, design light shows, configure and upload files to the LSE, and set playback parameters. The Light System Manager User Guide also contains a tutorial section.



✳ Product Guides are available online at www.philipscolorkinetics.com/support/productguides/

✳ The Configuration Calculator is available online at www.philipscolorkinetics.com/support/install_tool/

✳ For detailed optical device Ethernet network specifications and installation steps, refer to your optical device user documentation.



✳ The Addressing and Configuration Guide and QuickPlay Pro software download are available at www.philipscolorkinetics.com/support/addressing/



✳ The Light System Manager User Guide is available online at www.philipscolorkinetics.com/ls/controllers/lsm/

Start the Installation

1. Install all lighting fixtures, power / data supplies, and Data Enabler Pro devices. If your installation calls for jumper cables to add space between fixtures, make sure they are available.
2. Verify that your LSE is installed on a dedicated LAN using standard Ethernet switches.
3. If using one or more Ethernet Controller Keypads, you must use a PoE (Power over Ethernet) switch, or install PoE injectors inline between each keypad and the switch to which it is connected.

Install Light System Manager

Light System Manager comprises two components: the Light System Engine controller and Light System Composer software:

LSE Installation Overview

- Install LSE in a convenient, temperature-controlled location. Use the Installation Instructions document included in the product packaging for step-by-step hardware installation instructions.
- Both LSE and the personal computer hosting LSC must be set up on a dedicated local area network.
- LSE automatically assigns an IP address to the personal computer on your dedicated network. After connecting the personal computer, verify that the computer can connect to the LSE. Note that following light show programming and configuration, you can disconnect and remove the personal computer from the network.
- Refer to the Light System Manager User Guide for network troubleshooting techniques, as needed. The Light System Manager User Guide is available online at www.colorkinetics.com/lsc/controllers/lsm/.



LSC Installation Overview

- Use the Light System Manager Quick Start Guide included in the product packaging for step-by-step software installation instructions.
- Install LSC software from the CD included in the product packaging or by downloading it from www.colorkinetics.com/lsc/controllers/lsm/.



Using the Light System Engine Interface

The LSE has a web-based interface for setting system time (used for accurate playback scheduling) and obtaining log files. Connect to the LSE interface by entering 10.1.3.100 in a web browser on the computer connected to the dedicated local area network. To access the System Time screen, enter a login of **lse** and a password of **lse**.

Light show and configuration files are stored on the LSE hard drive, enabling you to disconnect the personal computer on the lighting network once setup is complete. However, to perform live light show playback or change the light show files stored on the LSE, you must reconnect the personal computer. You can store hundreds of light shows on the LSE hard drive.

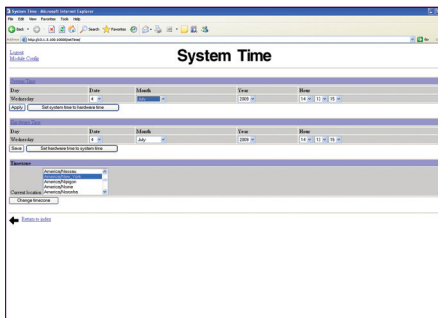

About Light System Composer Software

Light System Composer is a full-featured software package containing the following modules:

Management Tool — When connected to a lighting network, the Management Tool module automatically discovers all lighting system components, allowing you to create a map of the installation. The map identifies all hardware so that the LSE controller can send accurate light output instructions. Additionally, the map allows you to create groups of fixtures to simplify playback control.

Show Designer — The Show Designer module enables you to author and refine light shows using eight fixed color and chasing color effects, two animated image effects, and two geometric effects. You can apply pre-defined effects to fixtures, and then modify those effects by modifying their parameters. Show Designer also allows you to simulate your show via the Live Play simulation feature, which displays the light shows on the fixtures in your installation.

Config Maker — The Config Maker module provides an interface to program playback zones, schedule show playback, and set triggers for external triggering devices, such as the Ethernet Controller Keypad. Once configuration is complete, the Config Maker module uploads your config file to the LSE for storage and playback.

Playback Control — Use the Playback Control module to trigger light shows from a computer on the lighting network, or pause and refresh LSE playback. The Playback Control module also allows you to view scheduled events and access system information.

Management Tool

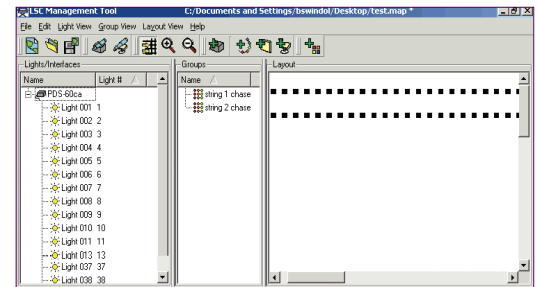

Show Designer

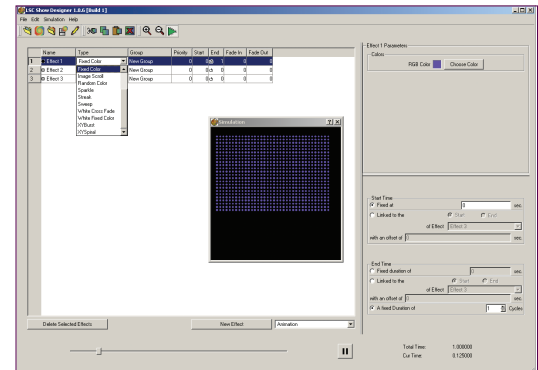

Config Maker

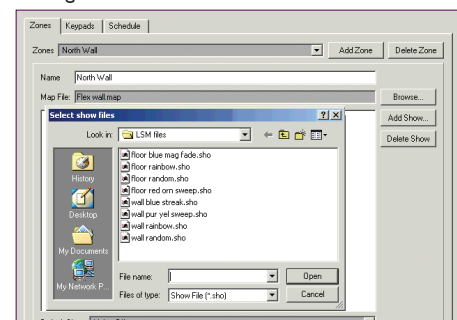

Playback Control

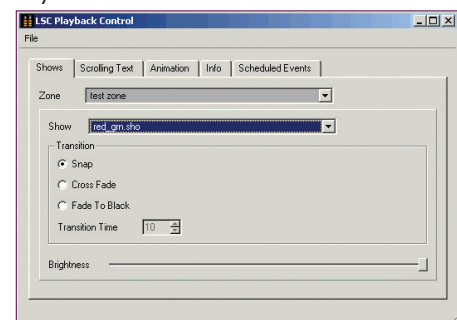

Workflow: Creating and Displaying a Light Show

1. Create a Map

The first step in creating a light show is to map the installation. The map links all lighting fixtures and interfaces (power / data supplies and Data Enablers) to the LSE controller, and acts as a virtual representation of the installation. The Management Tool module enables you to automatically discover all lighting system components and build the map. When new fixtures are added to an existing installation, or when working off site, the Management Tool module also allows you to manually build a fully functional virtual map.

2. Create a Light Show

When the map is completed, the next step is to create a light show with one or more effects. The Show Designer module lets you add effects to each group of fixtures in the installation and then modify the effect parameters to create unique results. Use the Live Play feature to test and refine your show.

3. Set Triggers, Create Zones, and Download Files

When you have built a map and designed a light show, the next step is to configure playback schedules, playback zones, and keypad triggering in the Config Maker module. Once you have created configurations, associate them with a map file and show file, then upload to the LSE.

4. Playback Control

Once you have uploaded all files to the LSE, the LSE will automatically play back the show files based on the scheduling you configured with the Config Maker module. You can use the Playback Control module to override automated scheduling and trigger on-demand light shows from a computer on the lighting network.

Light System Manager Effects Palette



Welcome Wall at the Potawatomi Bingo Casino
Milwaukee, Wisconsin

Photography Marty Peck,
Creative Lighting Design & Engineering

The Light System Composer Show Designer module offers a palette of fourteen pre-defined visual effects:

Animation

A series of still images appears in rapid succession, creating an animation sequence.

Chasing Rainbow

When applied to a group of fixtures, colors of the rainbow appear to chase each other from fixture to fixture.

Color Sweep

When applied to a group of fixtures, a color advances from fixture to fixture in a sweeping motion.

Cross Fade

Colors fade gracefully from a solid color to another solid color.

Custom Rainbow

Custom Rainbow is similar to Chasing Rainbow, but allows a choice of colors.

Fixed Color

Static display of a single color.

Image Scroll

A still image moves across the fixtures in a user-defined motion.

Random Color

At specified intervals, colors jump cut from one color to the next, in random order.

Sparkle

When applied to a group of fixtures, flashes of light appears on several fixtures in the group, in random order.

Streak

When applied to a group of fixtures, a pulse of color races from fixture to fixture.

XY-Burst

Produces multiple expanding concentric circles of color.

XY-Spiral

Produces a color-changing wheel revolving around a center point.

White Cross Fade

Produces white light that fades between a start color temperature and intensity and an end color temperature and intensity (for use with IntelliWhite fixtures).

White Fixed Color

Produces a static display of a user-specified fixed color temperature and intensity (for use with IntelliWhite fixtures).

Light System Manager On Display

Headquartered in Burlington, Massachusetts, Philips Color Kinetics is a global LED lighting innovation and product design center for Philips. The 50,000 square ft (4,645 square m) office, laboratory, and showroom space utilizes LED lighting technology throughout. Light System Manager manages the LED lighting zones in the building, including the lobby, conference rooms, work spaces, exterior signage, and product demonstration areas.

Lighting Zone Details

The lobby space features subtly animated light shows displayed on both RGB and white LED lighting systems. 20 unique shows ranging in duration from 10 minutes to 12 hours gently scroll across the ceiling, wall surfaces, and alcoves. Additionally, the fixtures installed directly above the reception desk are controlled by LSM as a separate region within the lobby zone, allowing for warm white illumination focused on the receptionist work space and visitor seating area, as needed.

How it Works

LSM uses two-dimensional maps to identify and control the lighting components in each lighting zone. The lobby map, for example, contains four rectangular clusters of fixtures, varying in size. The large rectangular area corresponds to the main ceiling, and the smaller rectangular areas match the wall adjacent to the elevator, the ceiling adjacent to the elevator, and the wall behind the reception desk.



Philips Color Kinetics
Headquarters and Showroom

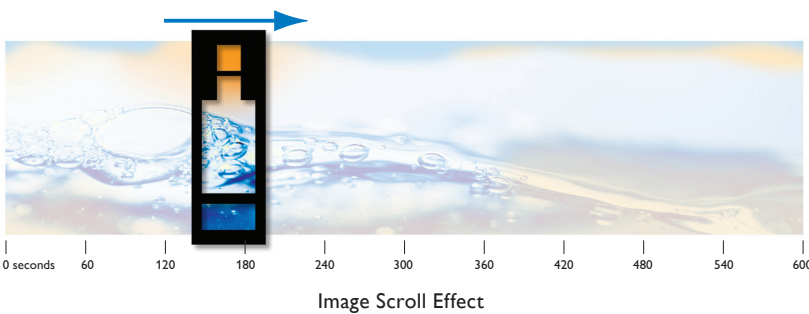
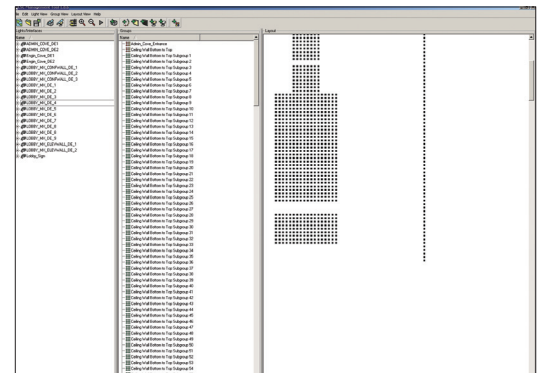
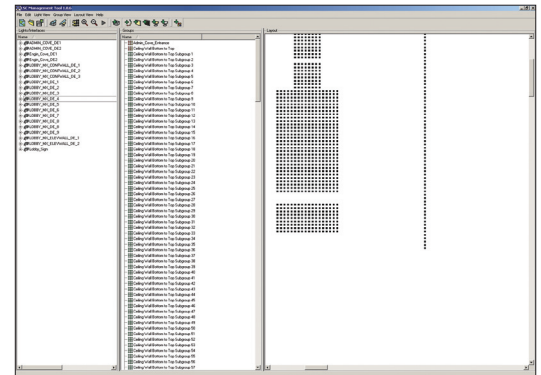

The lobby map allows LSM to accurately display light shows according to the position of each fixture. Based on a schedule, LSM continuously scrolls images (.BMP, .JPG) across the lobby map, creating a seamless animated effect. Because each image is configured to be larger than the map dimensions, only a portion of the image is displayed at any given time.

Playback Controls

Once set up, the LSM functions as a standalone device that automatically displays one or more scheduled light shows in each lighting zone. The lobby schedule calls for unique shows each day of the week and on certain holidays. Additionally, Ethernet Controller Keypads installed in multiple locations allow users to override a scheduled lobby show at the touch of a button and select from eight additional choices.



Philips Color Kinetics
3 Burlington Woods Drive
Burlington, Massachusetts 01803 USA
Tel 888.385.5742
Tel 617.423.9999
Fax 617.423.9998
www.philipscolorkinetics.com

Copyright © 2009 – 2014 Philips Solid-State Lighting Solutions, Inc. All rights reserved. Chromacore, Chromasic, CK, the CK logo, Color Kinetics, the Color Kinetics logo, ColorBlast, ColorBlaze, ColorBurst, eW Fuse, ColorGraze, ColorPlay, ColorReach, iW Reach, eW Reach, DIMand, EssentialWhite, eW, iColor, iColor Cove, IntelliWhite, iW, iPlayer, Optibin, and Powercore are either registered trademarks or trademarks of Philips Solid-State Lighting Solutions, Inc. in the United States and / or other countries. All other brand or product names are trademarks or registered trademarks of their respective owners. Due to continuous improvements and innovations, specifications may change without notice.
CN Tower cover photograph by George Fischer
DAS-000035-00 R05 02-14